

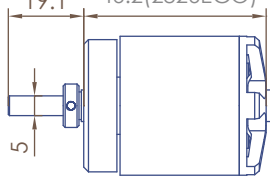

Dimensions

ECO 2808C-V2

28.2(2808ECO)
34.2(2814ECO)
40.2(2820ECO)
46.2(2826ECO)

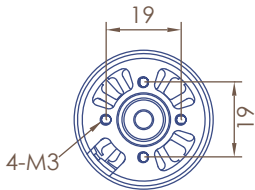

38.2(2808ECO)
44.2(2814ECO)
50.2(2820ECO)
56.2(2826ECO)

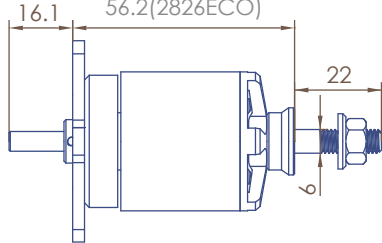
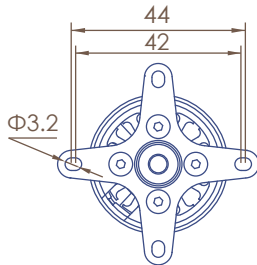
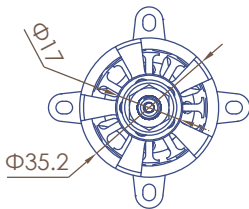

Specification

ECO-C Series	ECO 2808C		
SKU(商品编码)	51656	51657	51658
KV(KV值)	1430	1200	1000
Turns(匝数)	9	11	13
Weight(g)(重量)	75	75	75
Dimensions(D x L)[mm](尺寸)	35.2x28.2	35.2x28.2	35.2x28.2
Slots & Poles(槽数, 极数)	12N14P	12N14P	12N14P
Ri(mOhm)(电阻)	48.0	66.6	80.0
I _o @10V (A)(空载电流)	1.1	0.9	0.6
No.of Cells(LiPo)(适用电池)	2.3	2.3	3.4
Max. EfficiencyCurrent[A](效率电流)	20	17	15
Max. Burst Current (15S)[A](最大电流)	32	28	25
Max. Power(15S)[W](最大功率)	260	336	300
Max. Torque [N*M](最大扭矩)	0.26	0.27	0.29
Shaft diameter(mm)(轴径)	5	5	5
Mountingholes pitch(安装孔距)	19/19	19/19	19/19
Input Connectors(输入链接)	GC3.5	GC3.5	GC3.5
RecommendedESC(调速器)	XC-45-LITE or XC3012BA	XC-45-LITE or XC3012BA	XC-45-LITE or XC3012BA
Propeller(螺旋桨)	2S: 12x6E, 10x5E 3S: 8x5E, 7x5E	2S: 12x6E, 13x6.5E 3S: 10x6E, 9x4.5E	3S: 10x5E, 11x7E 4S: 9x4.5E, 8x6E
Class(适用机种)	480 size.10 Class		

ECO 2808C (1430KV)

7.4V Motor @ Optimum Efficiency 最佳效率点

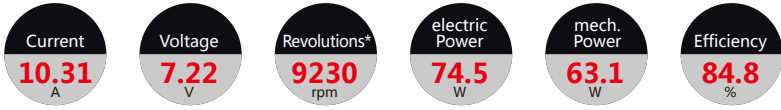

- ① el. Power [in 1W]
- ② Efficiency [%]
- ③ max. Revolutions [in 100rpm]
- ④ waste Power[W]
- ⑤ Motor Case Temp. [°C]

Motor Characteristics

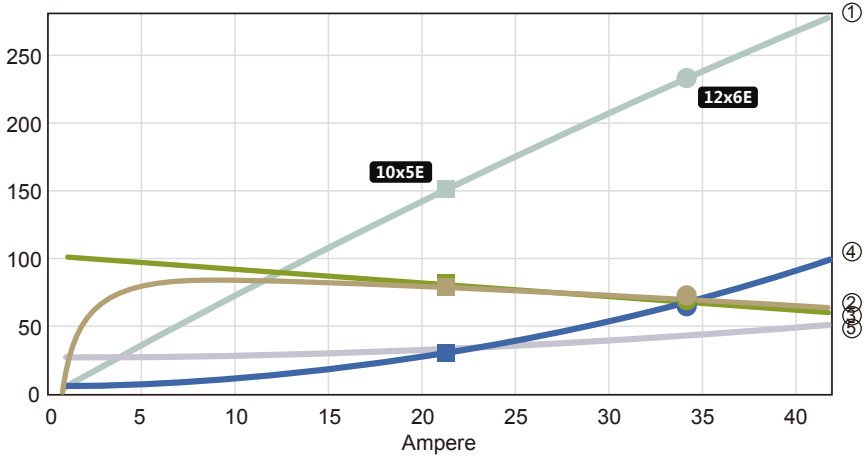

Voltage (V)	Propeller (RPM)	Throttle (%)	Current (A)	Volage (V)	el. Power (W)	Efficiency (%)	Thrust (g)	Spec. Thrust (g/W)
7.4V (2S LIPO)	10x5E							
	3000	32	1.1	7.4	7.9	74.3	121	15.4
	3600	39	1.8	7.4	12.9	78.1	174	13.5
	4200	46	2.7	7.4	20	80.2	237	11.9
	4800	53	4	7.3	29.4	81.4	310	10.5
	5400	61	5.7	7.3	41.6	81.9	392	9.4
	6000	69	7.9	7.3	57	82	484	8.5
	6600	77	10.6	7.3	76	81.9	586	7.7
	7200	85	13.9	7.2	99.1	81.5	697	7
	7800	94	17.9	7.1	126.6	81.1	819	6.5
	8171	100	20.9	7.1	147	80.5	898	6.1
	12x6E							
	2500	29	1.5	7.4	11.1	75.6	174	15.7
	3000	35	2.6	7.4	18.9	76.8	251	13.3
	3500	42	4.1	7.3	30	76.9	342	11.4
	4000	49	6.2	7.3	45.1	76.4	446	9.9
	4500	57	9	7.3	65	75.6	565	8.7
	5000	66	12.7	7.2	90.3	74.5	697	7.7
	5500	74	17.3	7.2	122.1	73.4	844	6.9
6000	84	23.1	7.1	161.1	72.2	1004	6.2	
6500	94	30.3	7	208.4	71	1179	5.7	
6758	100	34.9	6.9	237.7	70.1	1274	5.4	

11.1V Motor @ Optimum Efficiency 最佳效率点

Current
14.61
A

Voltage
10.75
V

Revolutions*
13789
rpm

electric Power
157.1
W

mech. Power
134.3
W

Efficiency
85.5
%

- ① el. Power [in 1W]
- ② Efficiency [%]
- ③ max. Revolutions [in 100rpm]
- ④ waste Power[W]
- ⑤ Motor Case Temp. [°C]

Motor Characteristics

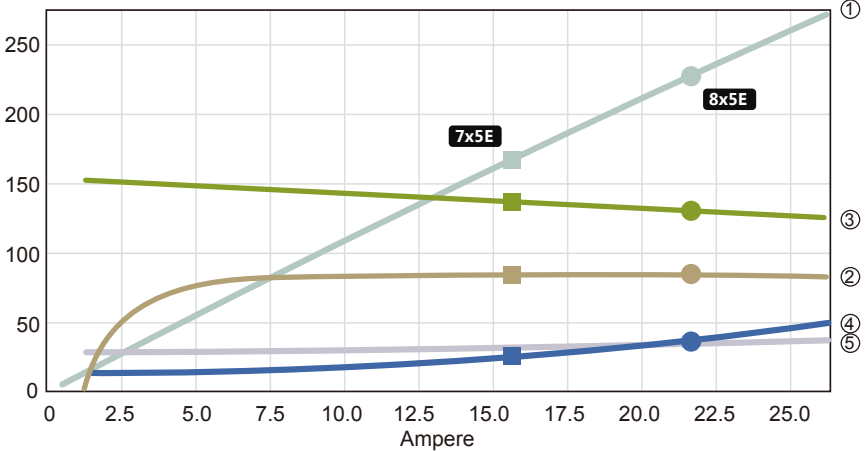

Voltage (V)	Propeller (RPM)	Throttle (%)	Current (A)	Volage (V)	el. Power (W)	Efficiency (%)	Thrust (g)	Spec. Thrust (g/W)	
7x5E									
11.1V (3S LIPO)	3000	20	0.3	11.1	2.9	48.4	42	14.3	
	4000	27	0.5	11.1	5.4	61.4	74	13.6	
	5000	34	0.8	11.1	9.3	70	115	12.4	
	6000	41	1.3	11.1	14.9	75.6	166	11.2	
	7000	48	2	11.1	22.5	79.2	226	10.1	
	8000	55	3	11	32.6	81.7	295	9.1	
	9000	62	4.1	11	45.5	83.3	374	8.2	
	10000	70	5.6	11	61.6	84.4	461	7.5	
	11000	78	7.4	10.9	81.2	85.1	558	6.9	
	12000	85	9.7	10.9	104.9	85.6	664	6.3	
	13000	94	12.3	10.8	132.9	85.9	780	5.9	
	13771	100	14.8	10.8	158.7	85.5	875	5.5	
	8x5E								
		3600	25	0.6	11.1	6.1	67.6	89	14.6
	4500	31	1	11.1	10.8	74.8	139	12.9	
	5400	37	1.6	11.1	17.6	79.2	201	11.4	
	6300	44	2.5	11	27.1	81.9	273	10.1	
	7200	51	3.6	11	39.6	83.5	357	9	
	8100	58	5.1	11	55.8	84.4	452	8.1	
	9000	65	7	11	76.1	85	558	7.3	
	9900	72	9.3	10.9	101	85.2	675	6.7	
	10800	80	12.1	10.8	131	85.2	803	6.1	
	11700	88	15.6	10.8	166.8	85.1	943	5.7	
	12600	96	19.7	10.7	208.8	84.9	1094	5.2	
	12992	100	21.9	10.6	231.1	84.4	1163	5	

ECO 2808C (1200KV)

7.4V Motor @ Optimum Efficiency 最佳效率点

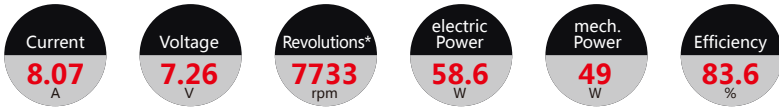

- ① el. Power [in 1W]
- ② Efficiency [%]
- ③ max. Revolutions [in 100rpm]
- ④ waste Power[W]
- ⑤ Motor Case Temp. [°C]

Motor Characteristics

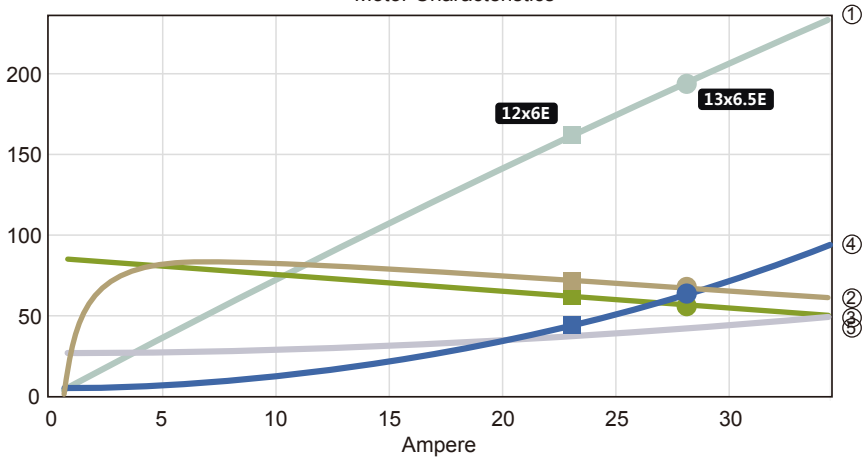

Voltage (V)	Propeller (RPM)	Throttle (%)	Current (A)	Volage (V)	el. Power (W)	Efficiency (%)	Thrust (g)	Spec. Thrust (g/W)
7.4V (2S LIPO)	12x6E							
	2800	39	2.1	7.4	15.5	76.3	219	14.1
	3200	45	3.1	7.4	23	76.9	286	12.4
	3600	52	4.5	7.3	32.7	76.9	362	11.1
	4000	59	6.2	7.3	45.1	76.5	446	9.9
	4400	66	8.4	7.3	60.4	75.9	540	8.9
	4800	73	11	7.2	79.3	75.2	643	8.1
	5200	81	14.3	7.2	101.9	74.3	754	7.4
	5600	90	18.2	7.1	128.8	73.4	875	6.8
	6000	99	22.9	7.1	160.5	72.5	1004	6.3
	6041	100	23.6	7.1	165	72.2	1018	6.2
	13x6.5E							
	2000	28	1.2	7.4	8.8	73	154	17.4
	2400	34	2	7.4	15	74.1	221	14.8
	2800	41	3.3	7.4	23.8	74.2	301	12.7
	3200	49	4.9	7.3	35.8	73.6	393	11
	3600	56	7.1	7.3	51.6	72.7	498	9.7
	4000	64	10	7.3	71.9	71.5	615	8.6
	4400	73	13.7	7.2	97.4	70.3	744	7.6
	4800	82	18.2	7.1	128.7	69	885	6.9
5200	92	23.9	7.1	166.8	67.7	1039	6.2	
5477	100	28.8	7	198.6	66.6	1153	5.8	

11.1V Motor @ Optimum Efficiency 最佳效率点

Current
11.29
A

Voltage
10.83
V

Revolutions*
11597
rpm

electric Power
122.2
W

mech. Power
103.4
W

Efficiency
84.7
%

- ① el. Power [in 2W]
- ② Efficiency [%]
- ③ max. Revolutions [in 100rpm]
- ④ waste Power[W]
- ⑤ Motor Case Temp. [°C]

Motor Characteristics

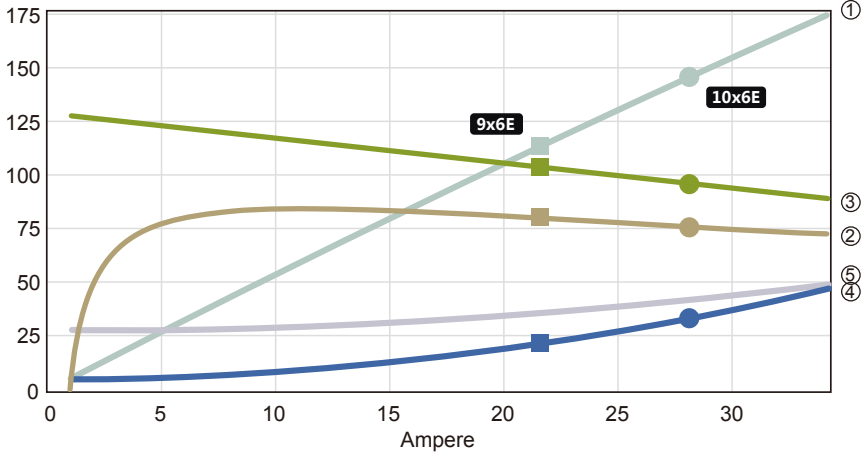

Voltage (V)	Propeller (RPM)	Throttle (%)	Current (A)	Volage (V)	el. Power (W)	Efficiency (%)	Thrust (g)	Spec. Thrust (g/W)
11.1V (3S LIPO)	9x6E							
	3500	29	0.9	11.1	9.7	75.1	144	14.8
	4200	36	1.5	11.1	16	78.8	208	13
	4900	42	2.2	11.1	24.8	81	283	11.4
	5600	49	3.3	11	36.4	82.2	369	10.1
	6300	55	4.7	11	51.5	82.7	467	9.1
	7000	62	6.5	11	70.5	82.9	577	8.2
	7700	70	8.6	10.9	93.9	82.8	698	7.4
	8400	77	11.3	10.9	122.3	82.6	830	6.8
	9100	85	14.6	10.8	156.3	82.2	975	6.2
	9800	93	18.4	10.7	196.3	81.7	1130	5.8
	10332	100	22.1	10.6	233.3	80.9	1256	5.4
	10x6E							
	2800	24	0.7	11.1	7.7	73.8	127	16.4
	3500	30	1.3	11.1	14.3	78.1	198	13.9
	4200	37	2.2	11.1	24	80.1	285	11.9
	4900	44	3.4	11	37.8	80.9	388	10.3
	5600	51	5.2	11	56.3	81	506	9
	6300	59	7.4	10.9	80.5	80.7	641	8
	7000	67	10.3	10.9	111.1	80.2	791	7.1
7700	75	13.9	10.8	149.2	79.5	957	6.4	
8400	84	18.4	10.7	195.7	78.7	1139	5.8	
9100	93	23.9	10.6	251.5	77.8	1337	5.3	
9569	100	28.6	10.5	297.6	76.8	1478	5	

ECO 2808C (1000KV)

11.1V Motor @ Optimum Efficiency 最佳效率点

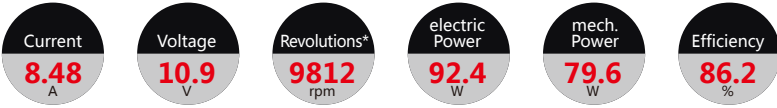

- ① el.Power [in 2W]
- ② Efficiency [%]
- ③ max. Revolutions [in 100rpm]
- ④ waste Power[W]
- ⑤ Motor Case Temp. [°C]

Motor Characteristics

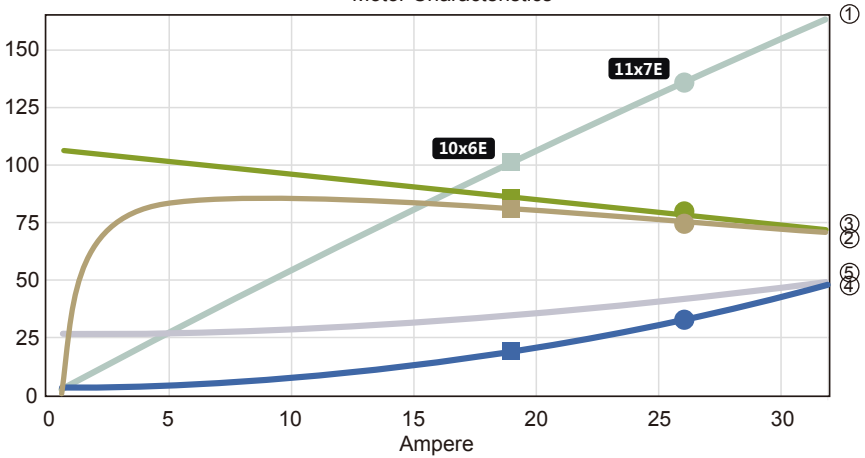

Voltage (V)	Propeller (RPM)	Throttle (%)	Current (A)	Voltage (V)	el. Power (W)	Efficiency (%)	Thrust (g)	Spec. Thrust (g/W)
11.1V (3S LIPO)	10x6E							
	3600	37	1.4	11.1	14.9	81.2	209	14
	4200	43	2.1	11.1	23.3	82.7	285	12.2
	4800	50	3.1	11	34.4	83.4	372	10.8
	5400	57	4.5	11	48.9	83.6	471	9.6
	6000	65	6.2	11	67.2	83.5	581	8.6
	6600	72	8.3	10.9	89.8	83.1	703	7.8
	7200	80	10.8	10.9	117.3	82.7	837	7.1
	7800	88	14	10.8	150.1	82.1	982	6.5
	8400	97	17.7	10.7	188.9	81.5	1139	6
	8600	100	19.2	10.7	204.6	80.9	1194	5.8
	11x7E							
	3500	38	2.1	11.1	23.5	80.9	307	13.1
	4000	44	3.2	11	35	81	401	11.4
	4500	50	4.6	11	50.1	80.7	508	10.1
	5000	57	6.3	11	69.2	80.2	627	9.1
	5500	64	8.6	10.9	92.9	79.4	758	8.2
	6000	71	11.3	10.9	121.9	78.6	902	7.4
	6500	79	14.6	10.8	156.7	77.7	1059	6.8
	7000	87	18.6	10.7	198.1	76.8	1228	6.2
7500	95	23.4	10.6	246.6	75.9	1410	5.7	
7771	100	26.6	10.5	278.2	75.1	1514	5.4	

14.8V Motor @ Optimum Efficiency 最佳效率点

Current
11.23
A

Voltage
14.45
V

Revolutions*
13015
rpm

electric Power
162.2
W

mech. Power
140
W

Efficiency
86.3
%

- ① el. Power [in 2W]
- ② Efficiency [%]
- ③ max. Revolutions [in 100rpm]
- ④ waste Power[W]
- ⑤ Motor Case Temp. [°C]

Motor Characteristics

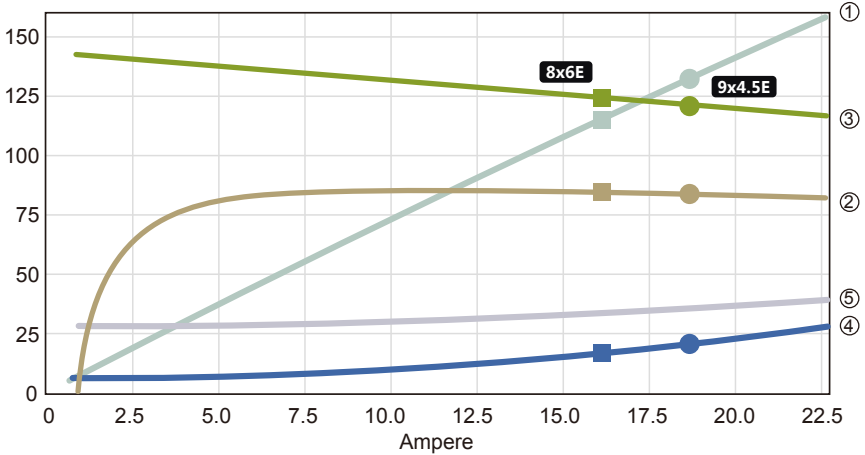

Voltage (V)	Propeller (RPM)	Throttle (%)	Current (A)	Volage (V)	el. Power (W)	Efficiency (%)	Thrust (g)	Spec. Thrust (g/W)
14.8V (4S LIPO)	8x6E							
	3600	26	0.5	14.8	6.8	72.9	107	15.7
	4500	33	0.8	14.8	12.3	78.9	167	13.6
	5400	40	1.4	14.8	20.3	82.3	241	11.8
	6300	47	2.1	14.7	31.6	84.3	328	10.4
	7200	54	3.2	14.7	46.5	85.4	429	9.2
	8100	62	4.5	14.7	65.7	86	542	8.3
	9000	69	6.2	14.6	89.9	86.3	670	7.5
	9900	77	8.2	14.6	119.6	86.3	810	6.8
	10800	85	10.8	14.5	155.4	86.2	964	6.2
	11700	93	13.8	14.4	198.2	86	1132	5.7
	12374	100	16.6	14.3	237	85.3	1266	5.3
	9x4.5E							
	3600	26	0.5	14.8	7.9	75.5	114	14.5
	4500	33	1	14.8	14.4	80.6	179	12.4
	5400	40	1.6	14.8	24.1	83.4	257	10.7
	6300	48	2.6	14.7	37.6	84.9	350	9.3
	7200	55	3.8	14.7	55.7	85.6	458	8.2
	8100	63	5.4	14.6	79.1	85.9	579	7.3
	9000	70	7.5	14.6	108.4	85.9	715	6.6
	9900	79	10	14.5	144.6	85.7	865	6
	10800	87	13.1	14.4	188.5	85.4	1030	5.5
11700	96	16.9	14.3	240.8	85	1208	5	
12095	100	18.9	14.3	269	84.4	1291	4.8	



Dimensions

ECO 2814C-V2

28.2(2808ECO)
34.2(2814ECO)
40.2(2820ECO)
46.2(2826ECO)

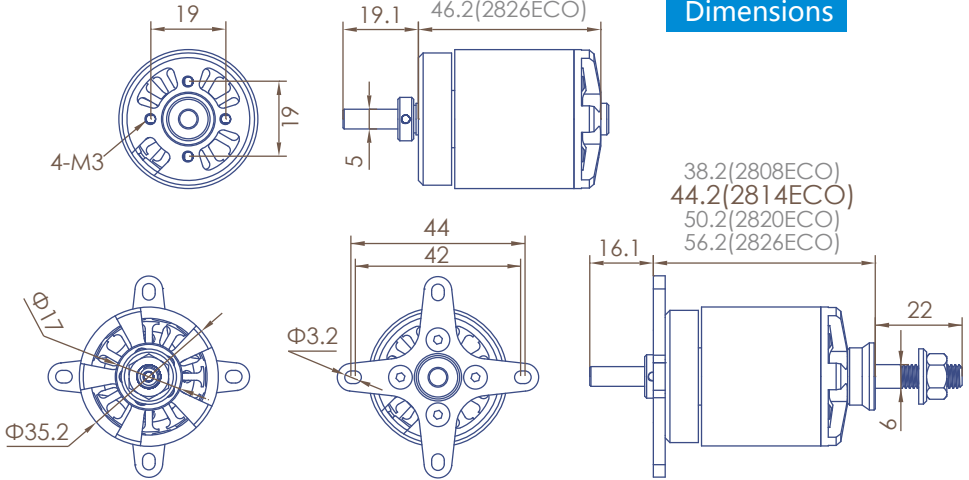

38.2(2808ECO)
44.2(2814ECO)
50.2(2820ECO)
56.2(2826ECO)

Specification

ECO-C Series	ECO 2814C			
SKU(商品编码)	51659	51660	51661	51662
KV(KV值)	1330	1120	970	860
Turns(匝数)	5.5	6.5	7.5	8.5
Weight(g)(重量)	105	105	105	105
Dimensions(D x L)[mm](尺寸)	35.2x34.2	35.2x34.2	35.2x34.2	35.2x34.2
Slots & Poles(槽数, 极数)	12N14P	12N14P	12N14P	12N14P
Ri(mOhm)(电阻)	29.6	37.8	48.6	63.0
I _o @10V (A)(空载电流)	1.8	1.2	1.0	0.8
No.of Cells(LiPo)(适用电池)	2.3	2.3	3.4	3.4
Max. EfficiencyCurrent[A](效率电流)	25	22	20	18
Max. Burst Current (15S)[A](最大电流)	40	36	33	30
Max. Power(15S)[W](最大功率)	480	432	400	480
Max. Torque [N*M](最大扭矩)	0.35	0.37	0.39	0.40
Shaft diameter(mm)(轴径)	5	5	5	5
Mountingholes pitch(安装孔距)	19/19	19/19	19/19	19/19
Input Connectors(输入链接)	GC3.5	GC3.5	GC3.5	GC3.5
RecommendedESC(调速器)	XC-45-LITE or XC4018BA	XC-45-LITE or XC4018BA	XC-45-LITE or XC4018BA	XC-45-LITE or XC4018BA
Propeller(螺旋桨)	2S: 12x6E, 13x6.5E 3S: 10x6E, 9x6E	3S: 9x6E, 10x6E, 11x4.5E	3S: 11x7E, 12x6E 4S: 9x6E, 8x4E	3S: 14x8.5E, 13x8E 4S: 12x4E, 10x5E
Class(适用机种)	.10-.15 Class			

ECO 2814C (1330KV)

7.4V Motor @ Optimum Efficiency 最佳效率点

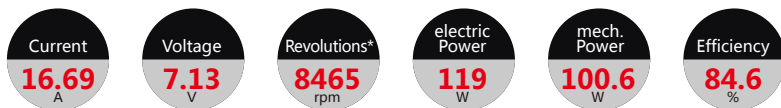

- ① el. Power [in 2W]
- ② Efficiency [%]
- ③ max. Revolutions [in 100rpm]
- ④ waste Power[W]
- ⑤ Motor Case Temp. [°C]

Motor Characteristics

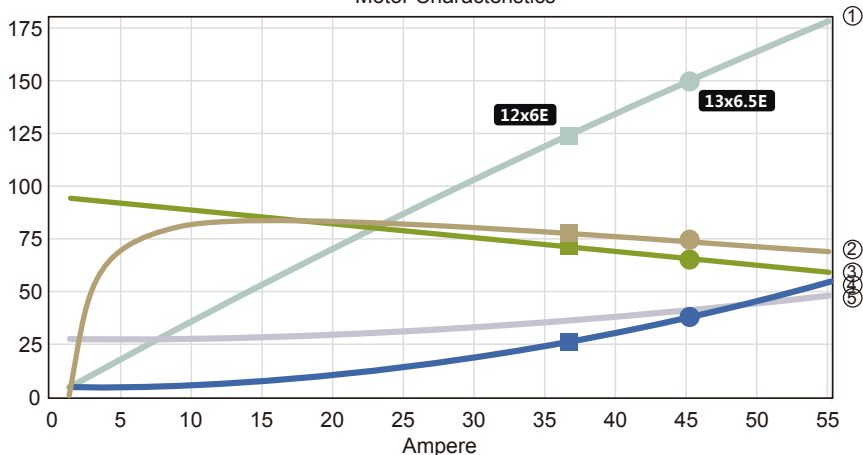

Voltage (V)	Propeller (RPM)	Throttle (%)	Current (A)	Volage (V)	el. Power (W)	Efficiency (%)	Thrust (g)	Spec. Thrust (g/W)
7.4V (2S LIPO)	12x6E							
	3000	35	2.6	7.4	18.9	76.9	251	13.3
	3500	42	4	7.3	29.2	79	342	11.7
	4000	48	5.9	7.3	43	80.2	446	10.4
	4500	55	8.4	7.3	60.8	80.7	565	9.3
	5000	63	11.6	7.2	83.3	80.8	697	8.4
	5500	71	15.6	7.2	111.2	80.6	844	7.6
	6000	79	20.6	7.1	145	80.2	1004	6.9
	6500	87	26.7	7	185.5	79.7	1179	6.4
	7000	97	34.1	6.9	233.4	79.2	1367	5.9
	7154	100	36.9	6.9	251.1	78.7	1428	5.7
	13x6.5E							
	2500	30	2.3	7.4	16.6	75.6	240	14.5
	3000	37	3.8	7.3	27.9	77.7	346	12.4
	3500	44	6.1	7.3	43.9	78.5	471	10.7
	4000	51	9.1	7.3	65.5	78.5	615	9.4
	4500	59	13.1	7.2	93.7	78.1	778	8.3
	5000	68	18.4	7.1	129.7	77.5	961	7.4
	5500	77	25.1	7	174.4	76.7	1162	6.7
6000	87	33.5	6.9	229.2	75.7	1383	6	
6500	98	44.2	6.8	295.2	74.8	1623	5.5	
6563	100	46	6.8	306.2	74.4	1655	5.4	

11.1V Motor @ Optimum Efficiency 最佳效率点

Current
23.36
A

Voltage
10.56
V

Revolutions*
12595
rpm

electric Power
246.7
W

mech. Power
210.8
W

Efficiency
85.5
%

- ① el. Power [in 2W]
- ② Efficiency [%]
- ③ max. Revolutions [in 100rpm]
- ④ waste Power[W]
- ⑤ Motor Case Temp. [°C]

Motor Characteristics

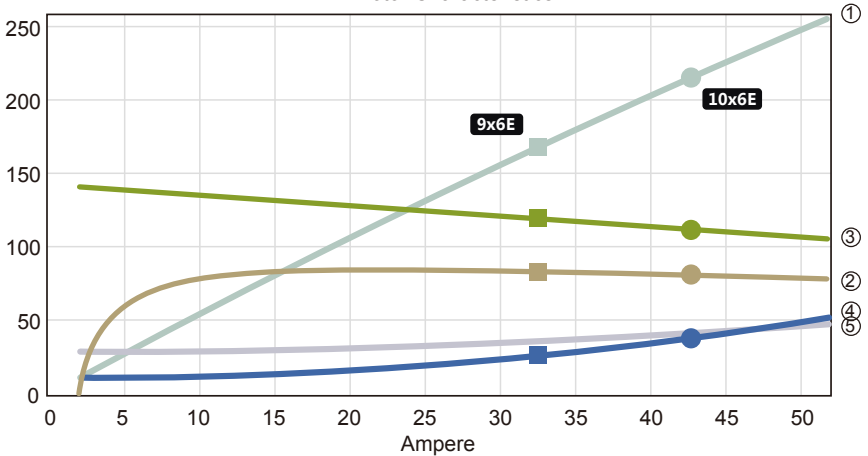

Voltage (V)	Propeller (RPM)	Throttle (%)	Current (A)	Volage (V)	el. Power (W)	Efficiency (%)	Thrust (g)	Spec. Thrust (g/W)
11.1V (3S LIPO)	9x6E							
	2700	20	0.5	11.1	5.9	57.1	86	14.6
	3600	26	1	11.1	11.6	68.7	153	13.2
	4500	33	1.9	11.1	20.5	75.7	238	11.6
	5400	40	3.1	11	33.6	79.8	343	10.2
	6300	48	4.7	11	51.8	82.3	467	9
	7200	55	7	11	75.9	83.8	610	8
	8100	63	9.9	10.9	107	84.6	772	7.2
	9000	71	13.6	10.8	146	85.1	953	6.5
	9900	79	18.2	10.7	194	85.2	1153	5.9
	10800	88	23.9	10.6	251.9	85.2	1373	5.4
	11700	98	30.9	10.5	320.8	85.1	1611	5
	11892	100	32.9	10.4	339.8	84.6	1665	4.9
	10x6E							
	2400	18	0.5	11.1	5.9	60.7	93	15.7
	3200	24	1.1	11.1	11.9	71.4	165	13.9
	4000	30	2	11.1	21.5	77.3	258	12
	4800	37	3.2	11	35.6	80.7	372	10.4
	5600	43	5.1	11	55.3	82.5	506	9.2
	6400	50	7.5	10.9	81.6	83.5	661	8.1
	7200	58	10.7	10.9	115.5	83.9	837	7.2
	8000	65	14.8	10.8	158.3	84	1033	6.5
	8800	73	19.9	10.7	211.1	83.8	1250	5.9
	9600	82	26.3	10.5	275.1	83.5	1488	5.4
10400	91	34.2	10.4	351.5	83.1	1746	5	
11126	100	43.2	10.2	436.7	82.2	1998	4.6	

ECO 2814C (1120KV)

11.1V Motor @ Optimum Efficiency 最佳效率点

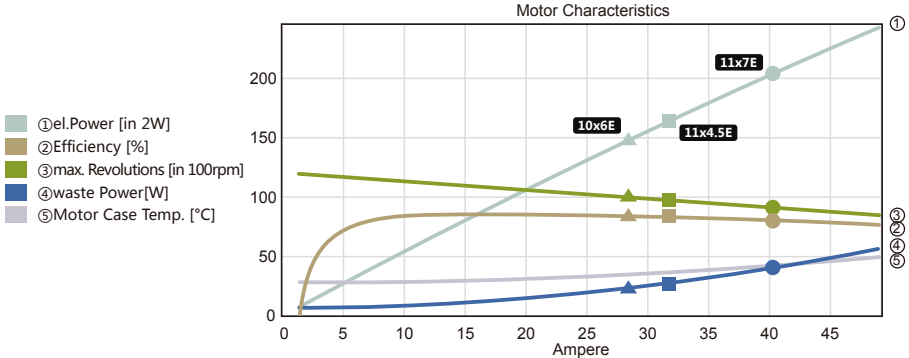
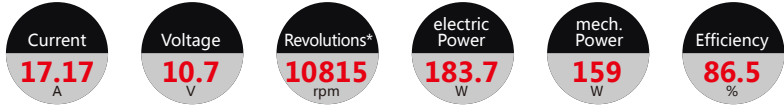

Voltage (V)	Propeller (RPM)	Throttle (%)	Current (A)	Volage (V)	el. Power (W)	Efficiency (%)	Thrust (g)	Spec. Thrust (g/W)
11.1V (3S LIPO)	10x6E							
	4200	37	2.2	11.1	23.8	80.8	285	12
	4900	44	3.3	11	36.8	83.1	388	10.5
	5600	51	4.9	11	54.1	84.4	506	9.4
	6300	58	7	11	76.3	85.1	641	8.4
	7000	65	9.6	10.9	104.3	85.4	791	7.6
	7700	73	12.9	10.8	138.7	85.5	957	6.9
	8400	81	16.9	10.7	180.2	85.4	1139	6.3
	9100	89	21.7	10.6	229.8	85.2	1337	5.8
	9800	98	27.5	10.5	288	84.9	1550	5.4
	9949	100	29.1	10.5	303.7	84.5	1598	5.3
	11x4.5E							
	4200	38	2.4	11.1	26	81.4	284	10.9
	4900	44	3.7	11	40.2	83.4	387	9.6
	5600	51	5.4	11	59.3	84.5	505	8.5
	6300	59	7.7	10.9	83.9	85	640	7.6
	7000	66	10.6	10.9	114.8	85.2	790	6.9
	7700	74	14.2	10.8	152.9	85.2	956	6.2
	8400	82	18.7	10.7	199	85	1137	5.7
	9100	91	24.1	10.6	254	84.6	1335	5.3
	9800	100	30.7	10.5	318.7	84.2	1548	4.9
	9811	100	31	10.4	322.1	83.9	1551	4.8
	11x7E							
	4200	39	3.6	11	39.7	82.7	442	11.1
	4800	45	5.4	11	58.9	83.4	578	9.8
	5400	52	7.7	10.9	83.6	83.5	731	8.7
	6000	58	10.6	10.9	114.9	83.4	902	7.9
	6600	66	14.3	10.8	153.6	83.1	1092	7.1
	7200	73	18.9	10.7	200.5	82.6	1300	6.5
	7800	81	24.4	10.6	256.7	82	1525	5.9
	8400	89	31.2	10.4	323.1	81.4	1769	5.5
	9000	98	39.3	10.3	400.7	80.7	2031	5.1
	9088	100	41	10.2	416.2	80.3	2070	5

ECO 2814C (970KV)

11.1V Motor @ Optimum Efficiency 最佳效率点

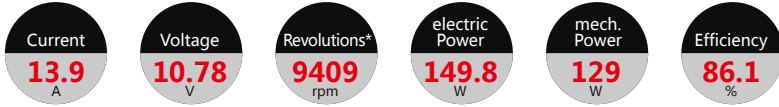

- ① el.Power [in 2W]
- ② Efficiency [%]
- ③ max. Revolutions [in 100rpm]
- ④ waste Power[W]
- ⑤ Motor Case Temp. [°C]

Motor Characteristics

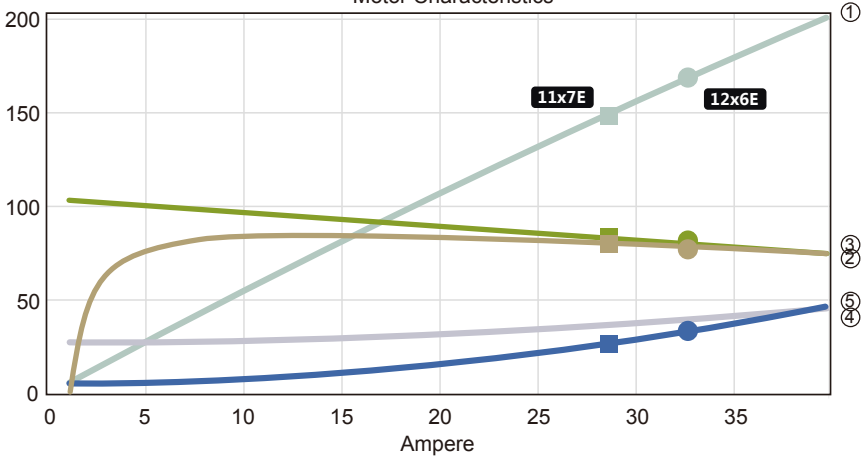

Voltage (V)	Propeller (RPM)	Throttle (%)	Current (A)	Volage (V)	el. Power (W)	Efficiency (%)	Thrust (g)	Spec. Thrust (g/W)
11x7E								
11.1V (3S LIPO)	3000	31	1.4	11.1	15.3	78.2	226	14.7
	3600	38	2.3	11.1	25.5	81.2	325	12.7
	4200	45	3.6	11	39.7	82.7	442	11.1
	4800	52	5.4	11	58.8	83.5	578	9.8
	5400	59	7.7	10.9	83.5	83.7	731	8.8
	6000	67	10.6	10.9	114.6	83.6	902	7.9
	6600	75	14.3	10.8	153.1	83.3	1092	7.1
	7200	84	18.8	10.7	199.9	82.9	1300	6.5
	7800	93	24.3	10.6	255.7	82.3	1525	6
	8253	100	29.4	10.5	306.6	81.6	1707	5.6
	12x6E							
11.1V (3S LIPO)	3000	32	1.7	11.1	18.3	79.4	251	13.7
	3600	38	2.8	11	30.8	81.6	362	11.7
	4200	46	4.4	11	48.3	82.6	492	10.2
	4800	53	6.6	11	71.9	82.9	643	8.9
	5400	61	9.5	10.9	102.5	82.7	813	7.9
	6000	69	13.1	10.8	141.3	82.3	1004	7.1
	6600	78	17.8	10.7	189.4	81.7	1215	6.4
	7200	87	23.5	10.6	248	81.1	1446	5.8
	7800	97	30.6	10.5	318.2	80.3	1697	5.3
	7972	100	33.2	10.4	343	79.8	1773	5.2

14.8V Motor @ Optimum Efficiency 最佳效率点

Current
18.28
A

Voltage
14.25
V

Revolutions*
12444
rpm

electric Power
260.4
W

mech. Power
224.7
W

Efficiency
86.3
%

- ① el. Power [in 2W]
- ② Efficiency [%]
- ③ max. Revolutions [in 100rpm]
- ④ waste Power[W]
- ⑤ Motor Case Temp. [°C]

Motor Characteristics

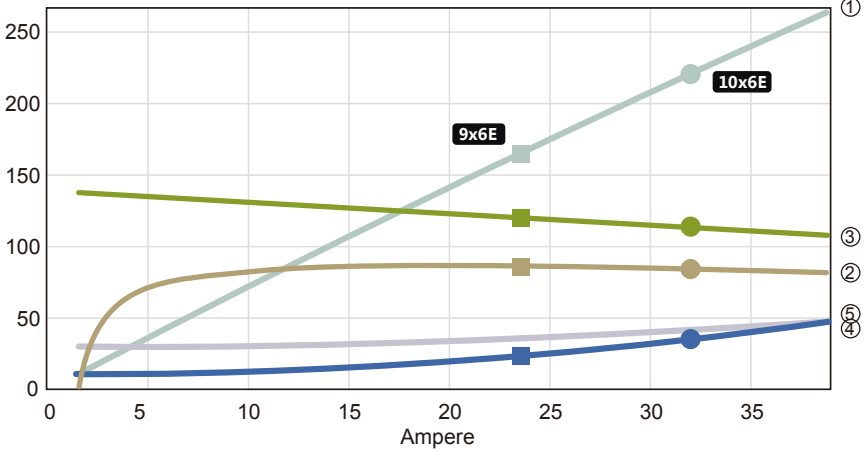

Voltage (V)	Propeller (RPM)	Throttle (%)	Current (A)	Volage (V)	el. Power (W)	Efficiency (%)	Thrust (g)	Spec. Thrust (g/W)
14.8V (4S LIPO)	9x6E							
	3600	27	0.8	14.8	11.1	71.6	153	13.7
	4500	34	1.4	14.8	19.9	77.9	238	12
	5400	41	2.2	14.7	32.9	81.7	343	10.4
	6300	48	3.5	14.7	50.8	83.9	467	9.2
	7200	56	5.1	14.7	74.6	85.2	610	8.2
	8100	64	7.2	14.6	105.4	86	772	7.3
	9000	71	9.9	14.5	143.9	86.3	953	6.6
	9900	80	13.3	14.4	191.2	86.5	1153	6
	10800	88	17.4	14.3	248.4	86.4	1373	5.5
	11700	97	22.4	14.2	316.3	86.3	1611	5.1
	11962	100	24.2	14.1	340.9	85.8	1684	4.9
	10x6E							
	4000	31	1.4	14.8	20.9	79.6	258	12.4
	4800	37	2.4	14.7	34.8	82.6	372	10.7
	5600	44	3.7	14.7	54.1	84.3	506	9.4
	6400	51	5.5	14.6	80	85.1	661	8.3
	7200	58	7.8	14.6	113.4	85.5	837	7.4
	8000	65	10.8	14.5	155.5	85.5	1033	6.6
	8800	73	14.5	14.4	207.3	85.4	1250	6
9600	81	19	14.3	270.1	85.1	1488	5.5	
10400	90	24.6	14.1	344.9	84.7	1746	5.1	
11200	99	31.3	13.9	433.1	84.3	2025	4.7	
11295	100	32.5	13.9	448.7	83.7	2060	4.6	

ECO 2814C (860KV)

11.1V Motor @ Optimum Efficiency 最佳效率点

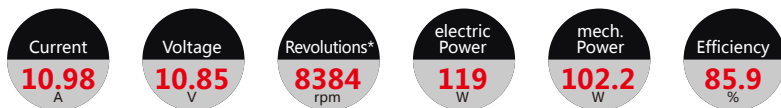

- ① el. Power [in 2W]
- ② Efficiency [%]
- ③ max. Revolutions [in 100rpm]
- ④ waste Power[W]
- ⑤ Motor Case Temp. [°C]

Motor Characteristics

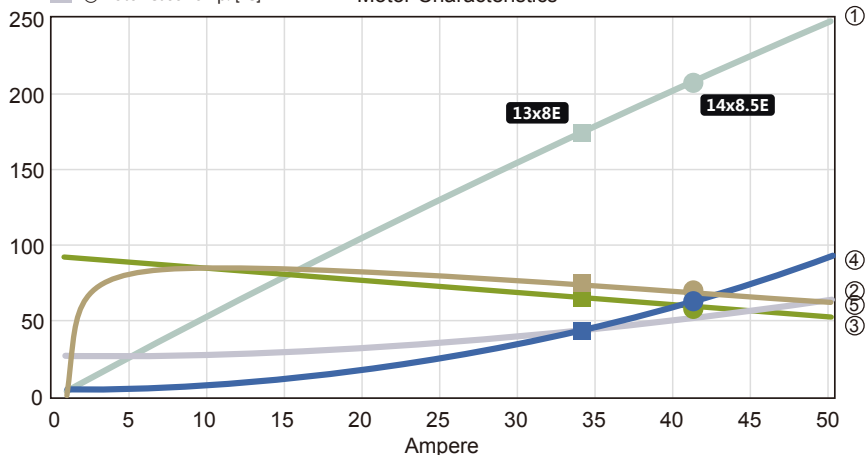

Voltage (V)	Propeller (RPM)	Throttle (%)	Current (A)	Volage (V)	el. Power (W)	Efficiency (%)	Thrust (g)	Spec. Thrust (g/W)
11.1V (3S LIPO)								
13x8E								
2400	30	1.6	11.1	17.4	78.5	272	15.6	
2800	35	2.5	11	27.3	79.6	371	13.6	
3200	41	3.7	11	40.6	79.8	484	11.9	
3600	47	5.3	11	58	79.6	613	10.6	
4000	53	7.3	10.9	80	79.2	757	9.5	
4400	60	9.9	10.9	107.4	78.5	916	8.5	
4800	67	13.1	10.8	140.8	77.7	1090	7.7	
5200	74	17	10.7	181	76.8	1279	7.1	
5600	82	21.6	10.6	228.7	75.9	1483	6.5	
6000	90	27.2	10.5	284.8	75	1703	6	
6400	99	33.9	10.4	350	74.1	1937	5.5	
6453	100	35.2	10.4	361.6	73.7	1969	5.4	
14x8.5E								
2400	31	2.3	11.1	25.2	77.7	361	14.4	
2800	37	3.6	11	40	77.6	492	12.3	
3200	44	5.5	11	60.2	76.9	643	10.7	
3600	50	8	10.9	86.8	76	813	9.4	
4000	58	11.2	10.9	120.8	74.9	1004	8.3	
4400	65	15.3	10.8	163.3	73.7	1215	7.4	
4800	73	20.4	10.7	215.7	72.5	1446	6.7	
5200	82	26.7	10.5	279	71.2	1697	6.1	
5600	92	34.5	10.4	354.7	70	1968	5.5	
5909	100	42	10.2	425.1	68.8	2191	5.2	

14.8V Motor @ Optimum Efficiency 最佳效率点

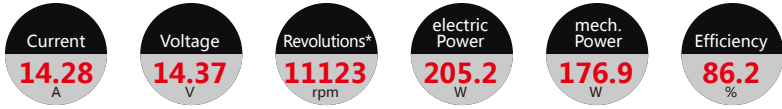

- ① el. Power [in 2W]
- ② Efficiency [%]
- ③ max. Revolutions [in 100rpm]
- ④ waste Power[W]
- ⑤ Motor Case Temp. [°C]

Motor Characteristics

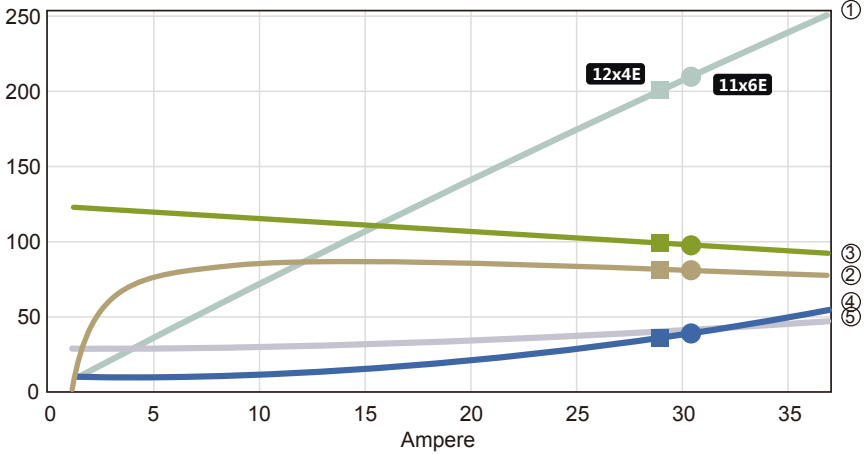

Voltage (V)	Propeller (RPM)	Throttle (%)	Current (A)	Voltage (V)	el. Power (W)	Efficiency (%)	Thrust (g)	Spec. Thrust (g/W)
12x4E								
14.8V (4S LIPO)	3500	31	1.3	14.8	19.2	80	228	11.8
	4200	37	2.2	14.7	32.2	82.6	328	10.2
	4900	44	3.4	14.7	50.4	83.9	447	8.9
	5600	51	5.1	14.7	74.7	84.4	583	7.8
	6300	58	7.3	14.6	106.2	84.5	738	6.9
	7000	66	10.1	14.5	146	84.3	911	6.2
	7700	74	13.6	14.4	195.2	84	1103	5.6
	8400	82	17.9	14.3	254.9	83.5	1312	5.1
	9100	91	23.2	14.2	326.2	82.9	1540	4.7
	9797	100	29.8	14	413.7	81.9	1785	4.3
11x6E								
14.8V (4S LIPO)	3500	31	1.4	14.8	20.3	80.4	263	13
	4200	37	2.3	14.7	34	82.7	379	11.1
	4900	44	3.6	14.7	53.3	83.9	516	9.7
	5600	51	5.4	14.6	79.2	84.3	674	8.5
	6300	59	7.8	14.6	112.8	84.3	853	7.6
	7000	66	10.7	14.5	155.3	84	1053	6.8
	7700	74	14.5	14.4	207.7	83.6	1274	6.1
	8400	83	19.1	14.3	271.5	83	1516	5.6
	9100	92	24.8	14.1	347.7	82.4	1779	5.1
	9702	100	30.9	13.9	428.1	81.4	2023	4.7